

# Panasonic<sup>®</sup>

## Quick Guide

SIP Cordless Phone

Model No. **KX-TGP500**    **B01**

Model No. **KX-TGP550**    **T01**

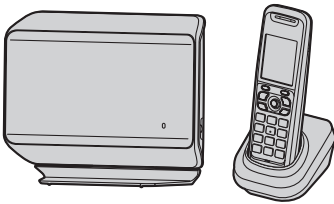

Model shown is KX-TGP500.

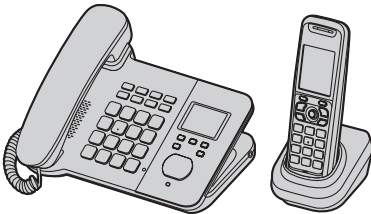

Model shown is KX-TGP550.

**Thank you for purchasing a Panasonic product.**

**Charge the batteries for about 6 hours before initial use.**

Please read this guide before using the unit and save it for future reference.

## **Table of Contents**

---

### **Introduction**

About this guide. . . . .	3
Accessory information. . . . .	3

### **Important Information**

For your safety . . . . .	4
Important safety instructions . . . . .	5
For best performance . . . . .	5
Security caution. . . . .	6
Other information. . . . .	6
Emergency calls . . . . .	7

### **Controls**

Handset. . . . .	8
Base unit . . . . .	9
 (status) indicator on the base unit	11

### **Basic Operations**

Making calls using the handset. . . . .	13
Making calls using the base unit (KX-TGP550 only) . . . . .	13
Answering calls using the handset . . . . .	14
Answering calls using the base unit (KX-TGP550 only) . . . . .	15
Hold. . . . .	15
Transferring calls . . . . .	15

### **Setting Up**

Setting up the base unit. . . . .	17
Setting up the handset . . . . .	19
Note when setting up. . . . .	19
Setting network . . . . .	20

### **Open Source Software**

Open Source Software . . . . .	22
--------------------------------	----

## About this guide

This guide explains how to use the basic features of KX-TGP500/KX-TGP550. For further information on operations and customising your phone, please read the User Guide on the Panasonic Web site at:

<http://panasonic.net/pcc/support/sipphone/>

Contact your administrator for further information.

## Accessory information

### Note:

- See page 17 for setting up the unit.

## Supplied accessories

No.	Accessory item/Part number	Quantity	
		KX-TGP500	KX-TGP550
①	AC adaptor/PQLV219CE	2	2
②	Ethernet cable	1	1
③	Base unit stand* <sup>1</sup>	1	–
④	Corded handset	–	1
⑤	Corded handset cord	–	1
⑥	Rechargeable batteries/HHR-65AAAB	2	2
⑦	Handset cover* <sup>2</sup>	1	1
⑧	Belt clip	1	1
⑨	Charger	1	1
⑩	Index sticker* <sup>3</sup>	–	1

\*1 The base unit stand comes attached to the base unit.

\*2 The handset cover comes attached to the handset.

\*3 Write down the names of 6 users and attach to the base unit (page 10).

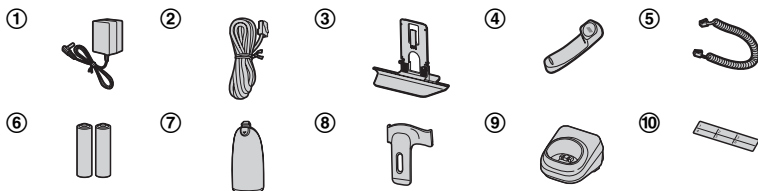

### For your safety

To prevent severe injury and loss of life/property, read this section carefully before using the product to ensure proper and safe operation of your product.

---

#### WARNING

##### Power connection

- Use only the power source marked on the product.
- Do not overload power outlets and extension cords. This can result in the risk of fire or electric shock.
- Completely insert the AC adaptor/power plug into the power outlet. Failure to do so may cause electric shock and/or excessive heat resulting in a fire.
- Regularly remove any dust, etc. from the AC adaptor/power plug by pulling it from the power outlet, then wiping with a dry cloth. Accumulated dust may cause an insulation defect from moisture, etc. resulting in a fire.
- Unplug the product from power outlets if it emits smoke, an abnormal smell, or makes an unusual noise. These conditions can cause fire or electric shock. Confirm that smoke has stopped emitting and contact your phone system dealer.
- Unplug from power outlets and never touch the inside of the product if its casing has been broken open.
- Never touch the plug with wet hands. Danger of electric shock exists.

---

##### Installation

- To prevent the risk of fire or electrical shock, do not expose the product to rain or any type of moisture.
- Do not place or use this product near automatically controlled devices such as automatic doors and fire alarms. Radio waves emitted from this product may cause such devices to malfunction resulting in an accident.
- Do not allow the AC adaptor or Ethernet cable to be excessively pulled, bent or placed under heavy objects.

---

##### Operating safeguards

- Unplug the product from power outlets before cleaning. Do not use liquid or aerosol cleaners.
- Do not disassemble the product.
- Do not spill liquids (detergents, cleansers, etc.) onto the Ethernet cable plug, or allow it to become wet at all. This may cause a fire. If the Ethernet cable plug becomes wet, immediately pull it from the LAN (Local Area Network) wall jack, and do not use.
- KX-TGP550 only: Do not excessively pull the corded handset cord from the base unit. This may cause the base unit to fall, resulting in injury.
- The use of excessive sound volume through earphones, headphones, or headsets may cause hearing loss.

---

##### Medical

- Consult the manufacturer of any personal medical devices, such as pacemakers or hearing aids, to determine if they are adequately shielded from external RF (radio frequency) energy. (The product operates in the frequency range of 1.88 GHz to 1.90 GHz, and the RF transmission power is 250 mW (max.))
- Do not use the product in health care facilities if any regulations posted in the area instruct you not to do so. Hospitals or health care facilities may be using equipment that could be sensitive to external RF energy.

---

#### CAUTION

---

##### Installation and relocation

- Never install LAN (Local Area Network) during an electrical storm.
- Never install Ethernet cable jacks in wet locations unless the jack is specifically designed for wet locations.
- Never touch uninsulated LAN (Local Area Network) or terminals unless the LAN (Local Area Network) has been disconnected at the network interface.
- Use caution when installing or modifying LAN (Local Area Network).
- The AC adaptor is used as the main disconnect device. Ensure that the AC outlet is installed near the product and is easily accessible.

- This product is unable to make calls when there is a power failure.

### Battery

- We recommend using the batteries noted on page 3. **USE ONLY rechargeable Ni-MH batteries AAA (R03) size.**
- Do not mix old and new batteries.
- Do not open or mutilate the batteries. Released electrolyte from the batteries is corrosive and may cause burns or injury to the eyes or skin. The electrolyte is toxic and may be harmful if swallowed.
- Exercise care when handling the batteries. Do not allow conductive materials such as rings, bracelets, or keys to touch the batteries, otherwise a short circuit may cause the batteries and/or the conductive material to overheat and cause burns.
- Charge the batteries provided with or identified for use with this product only, in accordance with the instructions and limitations specified in this manual.
- Only use a compatible charger to charge the batteries. Do not tamper with the charger. Failure to follow these instructions may cause the batteries to swell or explode.
- Batteries are supplied with this product. When they are empty, you should not throw them away. Instead, hand them in as small chemical waste.



## Important safety instructions

When using your product, basic safety precautions should always be followed to reduce the risk of fire, electric shock, and injury to persons, including the following:

1. Do not use this product near water for example, near a bathtub, washbowl,

kitchen sink, or laundry tub, in a wet basement or near a swimming pool.

2. Avoid using a telephone (other than a cordless type) during an electrical storm. There may be a remote risk of electric shock from lightning.
3. Do not use the telephone to report a gas leak in the vicinity of the leak.
4. Use only the power cord and batteries indicated in this manual. Do not dispose of batteries in a fire. They may explode. Check with local codes for possible special disposal instructions.

### SAVE THESE INSTRUCTIONS

## For best performance

### Base unit location/avoiding noise

The base unit and other compatible Panasonic units use radio waves to communicate with each other.

- For maximum coverage and noise-free communications, place your base unit:
  - at a convenient, high, and central location with no obstructions between the cordless handset and base unit in an indoor environment.
  - away from electronic appliances such as TVs, radios, personal computers, wireless devices, or other phones.
  - facing away from radio frequency transmitters, such as external antennas of mobile phone cell stations. (Avoid putting the base unit on a bay window or near a window.)
- Coverage and voice quality depends on the local environmental conditions.
- If the reception for a base unit location is not satisfactory, move the base unit to another location for better reception.

### Environment

- Keep the product away from electrical noise generating devices, such as fluorescent lamps and motors.
- The product should be kept free from excessive smoke, dust, high temperature, and vibration.
- The product should not be exposed to direct sunlight.
- Do not place heavy objects on top of the product.

## Important Information

---

- When you leave the product unused for a long period of time, unplug the product from the power outlet.
- The product should be kept away from heat sources such as radiators, cookers, etc. It should not be placed in rooms where the temperature is less than 0 °C or greater than 40 °C. Damp basements should also be avoided.
- The maximum calling distance may be shortened when the product is used in the following places: Near obstacles such as hills, tunnels, underground, near metal objects such as wire fences, etc.
- Operating the product near electrical appliances may cause interference. Move away from the electrical appliances.

---

### Routine care

- **Wipe the outer surface of the product with a soft moist cloth.**
- Do not use benzine, thinner, or any abrasive powder.

---

## Security caution

When using this product, take appropriate measures to avoid the following security breaches.

- Leaks of private information via this product
- Illegal use of this product by a third party
- Interference or suspension of the use of this product by a third party

Take the following measures to avoid security breaches:

- To prevent illegal access, keep the base unit software updated (if you do not have the latest version of software, this can lead to blocked access or information leaks). Refer to the User Guide on the Panasonic Web site. See page 3 for Panasonic URL.
- You are responsible for the security settings, such as the password for the Web user interface, to access this product. This information should not be made available to any third parties outside the user group. To prevent unauthorised access to this product, we recommend that you regularly change the password.
- Place this product where it is unlikely to be stolen.

- During an internet call, outside interference may occur resulting in improper call transmission and/or unit function.

---

## Other information

---

### Notice for product disposal, transfer, or return

- This product can store your private/confidential information. To protect your privacy/confidentiality, we recommend that you erase information such as phonebook or caller list entries, or the password for the Web user interface from the memory before you dispose of, transfer, or return the product. Contact your administrator about resetting the password for the Web user interface.

---

### General information

- In the event of problems, you should contact your phone system dealer in the first instance.

### Declaration of Conformity:

- Panasonic System Networks Co., Ltd. declares that this equipment is in compliance with the essential requirements and other relevant provisions of Radio & Telecommunications Terminal Equipment (R&TTE) Directive 1999/5/EC.

Declarations of Conformity for the relevant Panasonic products described in this manual are available for download by visiting:

<http://www.doc.panasonic.de>

### Contact to Authorised Representative:

Panasonic Testing Centre  
Panasonic Marketing Europe GmbH  
Winsbergring 15, 22525 Hamburg,  
Germany

---

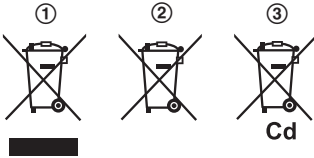
**Information for Users on Collection and Disposal of Old Equipment and used Batteries**

These symbols (①, ②, ③) on the products, packaging, and/or accompanying documents mean that used electrical and electronic products and batteries should not be mixed with general household waste.

For proper treatment, recovery and recycling of old products and used batteries, please take them to applicable collection points, in accordance with your national legislation and the Directives 2002/96/EC and 2006/66/EC. By disposing of these products and batteries correctly, you will help to save valuable resources and prevent any potential negative effects on human health and the environment which could otherwise arise from inappropriate waste handling.

For more information about collection and recycling of old products and batteries, please contact your local municipality, your waste disposal service or the point of sale where you purchased the items.

Penalties may be applicable for incorrect disposal of this waste, in accordance with national legislation.

---

**For business users in the European Union**

If you wish to discard electrical and electronic equipment, please contact your dealer or supplier for further information.

---

**Information on Disposal in other Countries outside the European Union**

These symbols (①, ②, ③) are only valid in the European Union. If you wish to discard these items, please contact your local authorities or dealer and ask for the correct method of disposal.

---

**Note for the battery symbol**

This symbol (②) might be used in combination with a chemical symbol (③). In this case it

complies with the requirement set by the Directive for the chemical involved.

---

**Emergency calls**

All lines including unassigned lines are available for emergency calls if the phone numbers are configured in the Web user interface. Availability depends on your phone system. Contact your administrator for further information.

## Handset

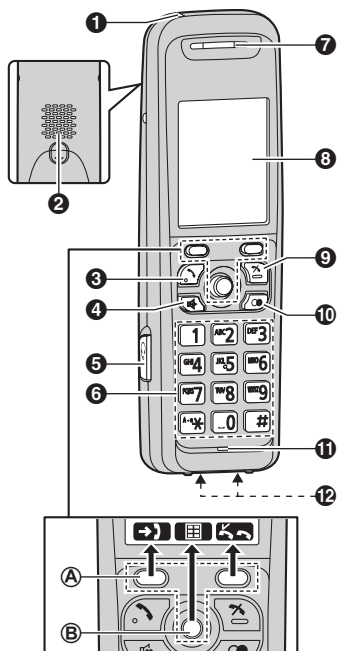

- 1** Charge indicator  
Ringer indicator  
Message indicator
- 2** Speaker
- 3** [ ] (Talk)
  - To make calls
- 4** [ ] (Speakerphone)
  - To talk hands-free
- 5** Headset jack
- 6** Dial keypad
- 7** Receiver
- 8** Display
- 9** [ ] (Off)
  - To stop operation
- 10** [ ] (Redial/Pause)
- 11** Microphone

## 12 Charge contacts

### ■ Control type

#### Ⓐ Soft keys

The handset features 2 soft keys and a joystick. By pressing a soft key, or by pressing the centre of the joystick, you can select the feature shown directly above it on the display.

#### Ⓑ Joystick

By pushing the joystick ([ ], [ ], [ ], or [ ]) repeatedly, you can:

- scroll through (up, down, left, or right) various lists or items
- adjust the receiver or speaker volume (up or down) while talking

## Temporarily switching the handset display mode

You can select to display either a single item or multiple items on one screen at a time for the phonebook list, caller list, and redial list.

You can temporarily switch the handset display mode as follows by pressing shown when viewing the lists with:

- multiple items are shown on one screen at a time.
- an item is shown on one screen at a time. You can confirm the detailed information.

---

## Base unit

---

### KX-TGP500

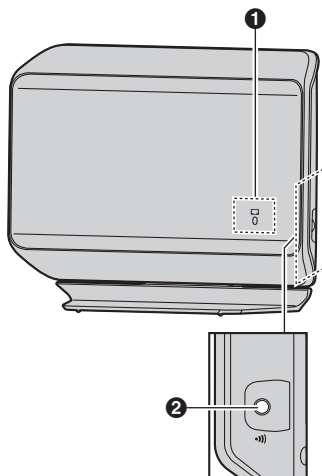

**1**  (Status) indicator

- Indicates the status of the unit and network.

**2**  (Handset locator button)

- Allows you to page all handsets.

## KX-TGP550

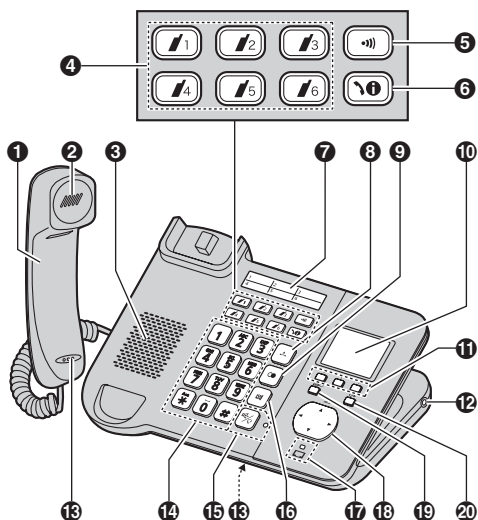

- |   |  |
|---|--|
| <p><b>1</b> Corded handset</p> <p><b>2</b> Receiver</p> <p><b>3</b> Speaker</p> <p><b>4</b> Handset paging buttons ([ /1 ] – [ /6 ])<br/>Handset status indicators</p> <ul style="list-style-type: none"> <li>• Allow you to page each handset. Also they show the status of each handset.</li> </ul> <p><b>5</b> [ handset icon ] (Handset paging button)</p> <ul style="list-style-type: none"> <li>• Allows you to page all handsets.</li> </ul> <p><b>6</b> [ handset icon / ] (Line status)</p> <ul style="list-style-type: none"> <li>• Tells you the status of each line on the display.</li> </ul> <p><b>7</b> Index sticker</p> <ul style="list-style-type: none"> <li>• You can write down the names of 6 users on the supplied index sticker and attach it to the base unit.</li> </ul> <p><b>8</b> [ hand icon ] (Hold)</p> <p><b>9</b> [ handset icon / dot ] (Redial) (Pause)</p> <p><b>10</b> Display</p> <p><b>11</b> Soft keys</p> | <p><b>12</b> Headset jack</p> <p><b>13</b> Microphone</p> <p><b>14</b> Dial keypad</p> <p><b>15</b> [ speaker icon ] (Speakerphone)<br/>[ headset icon ] (Headset)<br/>Speakerphone indicator</p> <p><b>16</b> [ X icon ] (Mute)</p> <p><b>17</b> [ status icon ] (Status) indicator</p> <ul style="list-style-type: none"> <li>• Indicates the status of the unit and network.</li> </ul> <p><b>18</b> Navigator key ([ &lt; ]/[ &gt; ]/[ left arrow ]/[ right arrow ])<br/>▲: Volume ([ &lt; ]/[ &gt; ])</p> <p><b>19</b> [ envelope icon ] (Voice mail)<sup>*1</sup><br/>[ envelope icon ] (Voice mail) indicator</p> <p><b>20</b> [ double arrow icon ] (Exit)</p> <ul style="list-style-type: none"> <li>• To stop operation</li> </ul> <p><sup>*1</sup> Your phone system needs to support voice mail. Contact your administrator for further information.</p> |
|---|--|

## Navigator key/volume key

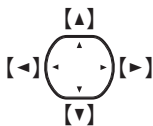

### ■ Scrolling through lists or items

By pressing this key ([▲], [▼], [◀], or [▶]) repeatedly, you can scroll through (up, down, left, or right) various lists or items.

### ■ Adjusting the volume

By pressing this key ([▲] or [▼]) repeatedly, you can adjust the receiver or speaker volume (up or down) while talking.

### ■ Moving the cursor

By pressing this key ([▲], [▼], [◀], or [▶]) repeatedly, you can move the cursor to edit a number or name.

## Soft keys

The base unit features 3 soft keys. By pressing a soft key, you can select the feature shown directly above it on the display.

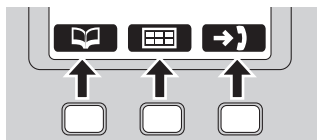



## ☐ (status) indicator on the base unit









During the startup process you may notice that the ☐ indicator on the base unit is flashing. This indicates that the base unit is booting up with your phone system. You may find the following flash patterns helpful:

Status		Meaning
Colour	Light pattern	
Green	On	<ul style="list-style-type: none"> <li>The base unit is connected to the Internet. The startup process is complete and you may now make and receive internet calls.</li> </ul>
	Flashing	<ul style="list-style-type: none"> <li>The base unit is downloading data. Do not disconnect the Ethernet cable or AC adaptor from the base unit until the ☐ indicator stops flashing and lights in steady green.</li> </ul>

## Controls

Status		Meaning
Colour	Light pattern	
Red	On	<ul style="list-style-type: none"> <li>When the base unit is turned on, the  indicator lights in red for about 10 seconds.</li> </ul>
	Flashing	<ul style="list-style-type: none"> <li>The base unit is registering a handset.</li> </ul>
	Flashing rapidly	<ul style="list-style-type: none"> <li>The base unit is paging handsets. (KX-TGP500 only)</li> </ul>
Amber	On	<ul style="list-style-type: none"> <li>The base unit's IP address may conflict with the IP addresses of other devices on your local network. Contact your administrator for further information.</li> </ul>
	Flashing	<ul style="list-style-type: none"> <li>The base unit is obtaining an IP address or is obtaining configurations. Please wait.</li> <li>The base unit is registering with your phone system. Please wait.</li> <li>If the  indicator continues flashing, check the following:               <ul style="list-style-type: none"> <li>Network settings may not be correct. Contact your administrator.</li> <li>Many installation issues can be resolved by resetting all the equipment. First, shut down your modem, router, hub, base unit, and computer. Then turn the devices back on one at a time in this order: modem, router, hub, base unit, computer.</li> <li>If you cannot access Internet Web pages using your computer, check to see if your phone system is having connection issues in your area.</li> <li>For more troubleshooting help, contact your administrator.</li> </ul> </li> </ul>
	Flashing rapidly	<ul style="list-style-type: none"> <li>Unplug the base unit's AC adaptor to reset the unit, then reconnect the AC adaptor. If the  indicator is still flashing rapidly, there may be a problem with the base unit hardware. Contact your phone system dealer.</li> </ul>
Off	—	<ul style="list-style-type: none"> <li>The base unit power is off.</li> <li>The Ethernet cable is not connected properly. Connect it.</li> <li>Your network devices (hub, router, etc.) are turned off. Check the LEDs for the link status of the devices.</li> <li>The base unit power is booting up.</li> </ul>







## Making calls using the handset

- Lift the handset and dial the phone number.
  - To correct a digit, press .
- Press  or .
  - The unit selects the default line configured by your administrator.
  - You can also select the line manually as follows:  
 → : Select the desired line. → 
- When you finish talking, press  or place the handset on the charger.

### Note:

- For further details, please read the User Guide on the Panasonic Web site. See page 3 for Panasonic URL.

## Using the speakerphone

- Dial the phone number and press .
  - The unit selects the default line configured by your administrator.
  - You can also select the line manually as follows:  
 → : Select the desired line. → 
  - Speak alternately with the other party.
- When you finish talking, press .

### Note:







- For best performance, use the speakerphone in a quiet environment.
- To switch back to the receiver, press .

## Adjusting the receiver or speaker volume





Push the joystick up or down repeatedly while talking.

## Making a call using the redial list

The last 10 phone numbers dialed are stored in the redial list (each 32 digits max.).

- .
- : Select the desired phone number.
- 
  - If  is pressed and the other party's line is engaged, the unit automatically redials multiple times. While the handset is waiting to redial, the ringer indicator flashes. To cancel, press .

## Making calls using the base unit (KX-TGP550 only)

- Dial the phone number.
  - To correct a digit, press .
- Lift the corded handset.
  - The unit selects the default line configured by your administrator.
  - You can also select the line manually as follows:  
 → : Select the desired line. → Lift the corded handset.
- When you finish talking, place the corded handset on the cradle.

## Basic Operations

### Note:

- You can also dial the phone number after lifting the corded handset.
- For further details, please read the User Guide on the Panasonic Web site. See page 3 for Panasonic URL.

## Using the speakerphone

- 1 Dial the phone number and press .
  - The unit selects the default line configured by your administrator.
  - You can also select the line manually as follows:  
 → **[▼]/[▲]**: Select the desired line. → Press or .
- 2 When the other party answers, speak into the base unit microphone.
  - Speak alternately with the other party.
- 3 When you finish talking, press .

### Note:

- For best performance, use the speakerphone in a quiet environment.
- To switch to the receiver, lift the corded handset.

## Adjusting the receiver or speaker volume

Press **[▲]** or **[▼]** repeatedly while talking.

## Making a call using the redial list

The last 10 phone numbers dialled are stored in the redial list in each unit (each 32 digits max.).

- 1
- 2 **[▼]/[▲]**: Select the desired phone number.

- 3 Lift the corded handset or press .
  - If is pressed and the other party's line is engaged, the unit automatically redials multiple times. While the base unit is waiting to redial, the speakerphone indicator on the base unit flashes. To cancel, press .

## Answering calls using the handset

When a call is being received, the ringer indicator on the handset flashes rapidly.

- 1 Lift the handset and press , , or when the unit rings.
  - You can also answer the call by pressing any dial key from **[0]** to **[9]**, **[\*]**, or **[#]**. (**Any key answer feature**)
- 2 When you finish talking, press or place the handset on the charger.

## Adjusting the handset ringer volume



### ■ While the handset is ringing for an incoming call:

Push the joystick up or down repeatedly to select the desired volume.

### ■ Programming the volume beforehand:



- 1 (centre of joystick) → **[#][1][6][0]**
- 2 **[▼]/[▲]**: Select the desired volume.
- 3 **OK** → **[\*]**

## Answering calls using the base unit (KX-TGP550 only)





- 1 Lift the corded handset or press  or  when the unit rings.
- 2 When you finish talking, place the corded handset on the cradle. When the speakerphone is used, press .

## Adjusting the base unit ringer volume

### ■ While the base unit is ringing for an incoming call:

Press  or  repeatedly to select the desired volume.



### ■ Programming the volume beforehand:

- 1  (middle soft key) → [1][6][0]
- 2 : Select the desired volume.
- 3 **OK** → 

## Hold

This feature allows you to put an outside call on hold.

### Handset



- 1 Press  during an outside call.
- 2 To release hold, press  or .

### Base unit

Available for: KX-TGP550

- 1 Press  during an outside call.

- If you are using the corded handset, you can place it on the cradle.

- 2 To release hold, lift the corded handset, or press  or .









## Transferring calls

Outside calls can be transferred to:







- another unit
- an outside party

## Using the handset

### Transferring calls to another unit

- 1 During an outside call, press .
- 2 /[]: “Intercom” → **OK**
- 3 /[]: Select the desired unit. → 
- 4 Wait for the paged party to answer.
  - If the paged party does not answer, press  to return to the outside call.
- 5 

### Transferring calls to an outside party

- 1 During an outside call, press .
- 2 /[]: “Transfer” → **OK**
- 3 Dial the phone number.
  - To correct the number, press  to clear the number and enter again.
- 4 Wait for the paged party to answer.
  - If the paged party does not answer, press  2 times to return to the outside call.
- 5 

### Using the base unit

Available for: KX-TGP550

#### Transferring calls to another unit

- 1 During an outside call, press **[F1]** – **[F6]** or **[\*]**.
- 2 Wait for the paged party to answer.
  - If the paged party does not answer, press the same button as in step 1 to return to the outside call.
- 3 Place the corded handset on the cradle.

#### Transferring calls to an outside party

- 1 During an outside call, press **[F1]**.
- 2 **[v]/[▲]**: “Transfer” → **OK**
- 3 Dial the phone number.
  - To correct the number, press **X** to clear the number and enter again.
- 4 Wait for the paged party to answer.
  - If the paged party does not answer, press **X** 2 times to return to the outside call.
- 5 **[↶]**

## Setting up the base unit

### Connecting the base unit

#### Important:

- Use only the supplied Panasonic AC adaptor PQLV219CE.
- Do not connect the Ethernet cable connected to the PoE hub to the computer port of the unit. Doing so may cause severe damage to the unit.

#### KX-TGP500

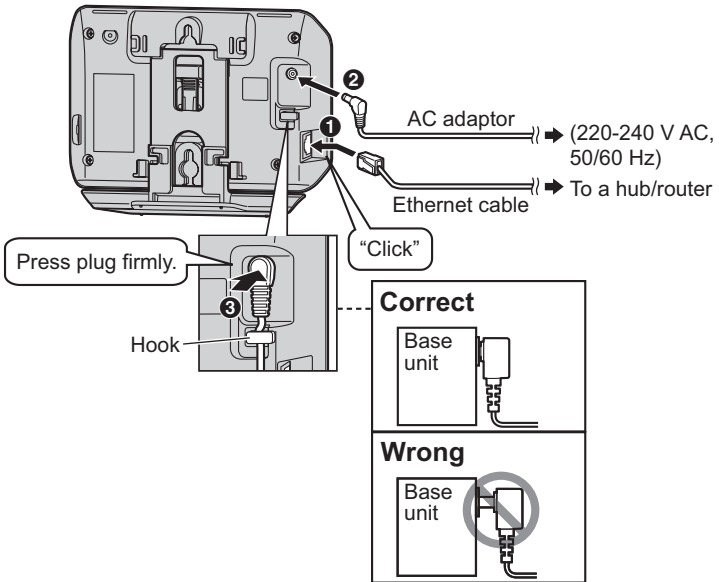

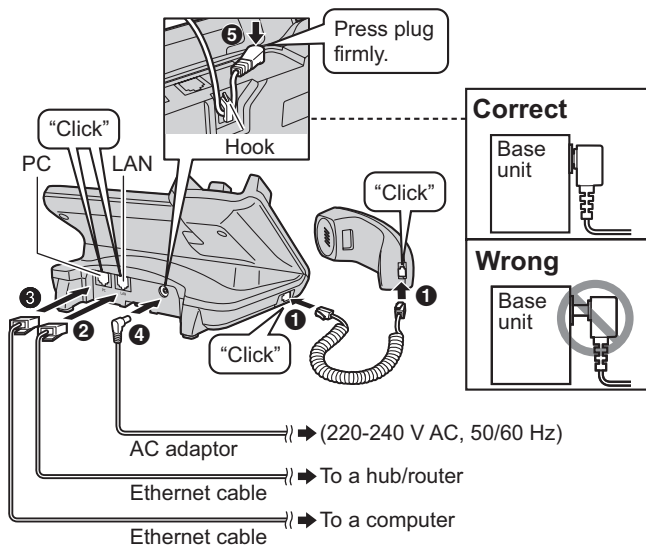

## Setting up the handset

### Connecting the charger

- Use only the supplied Panasonic AC adaptor PQLV219CE.

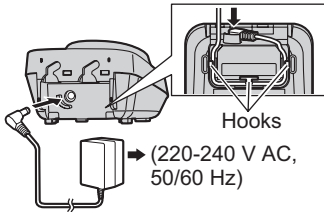

### Battery installation

- USE ONLY Ni-MH batteries AAA (R03) size.
- Do NOT use Alkaline/Manganese/Ni-Cd batteries.
- Confirm correct polarities ( $\oplus$ ,  $\ominus$ ).

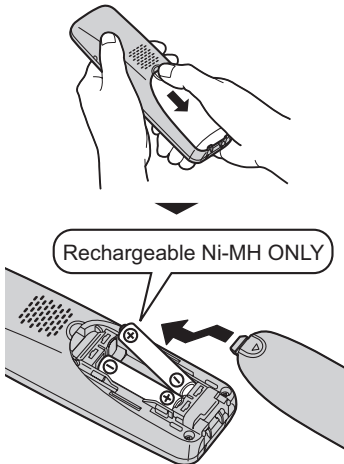

### Battery charge

Charge for about 6 hours.

- When the batteries are fully charged, the charge indicator goes off.

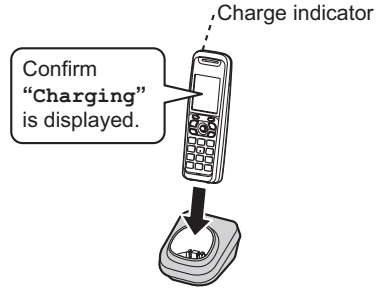

## Note when setting up

### Note for connections

- The AC adaptor must remain connected at all times. (It is normal for the adaptor to feel warm during use.)
- The AC adaptor should be connected to a vertically oriented or floor-mounted AC outlet. Do not connect the AC adaptor to a ceiling-mounted AC outlet, as the weight of the adaptor may cause it to become disconnected.
- The unit will not work during a power failure.

### Note for battery installation

- Use the supplied rechargeable batteries. For replacement, we recommend using the Panasonic rechargeable batteries noted in the User Guide on the Panasonic Web site. See page 3 for Panasonic URL.
- Wipe the battery ends ( $\oplus$ ,  $\ominus$ ) with a dry cloth.
- Avoid touching the battery ends ( $\oplus$ ,  $\ominus$ ) or the unit contacts.

## Setting Up

### Note for battery charge

- It is normal for the handset to feel warm during charging.
- Clean the charge contacts of the handset and charger with a soft and dry cloth once a month. Clean more often if the unit is exposed to grease, dust, or high humidity.

### Battery level

Icon	Battery level
	High
	Medium
	Low
	Needs charging.
	Empty

### Panasonic Ni-MH battery performance (supplied batteries)

Operation	Operating time
In continuous use	5 hours max.
Not in use (standby)	240 hours (10 days) max.

### Note:

- It is normal for batteries not to reach full capacity at the initial charge. Maximum battery performance is reached after a few complete cycles of charge/discharge (use).
- Actual battery performance depends on a combination of how often the handset is in use and how often it is not in use (standby).
- Even after the handset is fully charged, the handset can be left on the charger without any ill effect on the batteries.
- The battery level may not be displayed correctly after you replace

the batteries. In this case, place the handset on the charger and let it charge for at least 6 hours.

## Setting network

### Important:

- We recommend configuring these settings with your administrator. You can also configure the network settings through the Web user interface. Contact your administrator for further information.

### Automatic setup (default)

#### Turning the DHCP connection mode on

##### Handset

- 1 (centre of joystick) → **[#][5][0][0]**
- 2 **[v]/[^]**: "On" → **OK**
- 3 **[v]/[^]**: "Automatic" → **OK** → **[↶]**

##### Base unit

Available for: KX-TGP550

- 1 (middle soft key) → **[#][5][0][0]**
- 2 **[v]/[^]**: "On" → **OK**
- 3 **[v]/[^]**: "Automatic" → **OK** → **[↶]**

### Static setup

##### Handset

#### Turning the DHCP connection mode off

- 1 (centre of joystick) → **[#][5][0][0]**

2 **[▼]/[▲]**: “off” → **OK** → **[↶]**

### Setting the static IP address and other settings

- 1 **[⏏]** (centre of joystick) → **[⇦][5][0][1]**
- 2 Set the IP address, subnet mask, default gateway, DNS1, and DNS2.
  - Push the joystick down **[▼]** or up **[▲]** to move between the items.
  - To move the cursor, push the joystick right **[▶]** or left **[◀]**.  
To correct digits, press **C**.
- 3 **OK** → **[↶]**

#### Base unit

Available for: KX-TGP550

### Turning the DHCP connection mode off

- 1 **[⏏]** (middle soft key) → **[⇦][5][0][0]**
- 2 **[▼]/[▲]**: “off” → **OK** → **[↶]**

### Setting the static IP address and other settings

- 1 **[⏏]** (middle soft key) → **[⇦][5][0][1]**
- 2 Set the IP address, subnet mask, default gateway, DNS1, and DNS2.
  - Press **[▼]** or **[▲]** to move between the items.
  - To move the cursor, press **[▶]** or **[◀]**.  
To correct digits, press **C**.
- 3 **OK** → **[↶]**

# Open Source Software

Parts of this product use Open Source Software. Relevant conditions apply to this software. Panasonic cannot accept inquiries regarding the content of the following copyright and licence information.

<<NetBSD kernel>>

This product uses a part of NetBSD kernel.

The use of a part of NetBSD kernel is based on the typical BSD style license below.

Copyright (c)

The Regents of the University of California. All rights reserved.

Redistribution and use in source and binary forms, with or without modification, are permitted provided that the following conditions are met:

1. Redistributions of source code must retain the above copyright notice, this list of conditions and the following disclaimer.
2. Redistributions in binary form must reproduce the above copyright notice, this list of conditions and the following disclaimer in the documentation and/or other materials provided with the distribution.
3. All advertising materials mentioning features or use of this software must display the following acknowledgement:  
This product includes software developed by the University of California, Berkeley and its contributors.
4. Neither the name of the University nor the names of its contributors may be used to endorse or promote products derived from this software without specific prior written permission.

THIS SOFTWARE IS PROVIDED BY THE REGENTS AND CONTRIBUTORS "AS IS" AND ANY EXPRESS OR IMPLIED WARRANTIES, INCLUDING, BUT NOT LIMITED TO, THE IMPLIED WARRANTIES OF MERCHANTABILITY AND FITNESS FOR A PARTICULAR PURPOSE ARE DISCLAIMED. IN NO EVENT SHALL THE REGENTS OR CONTRIBUTORS BE LIABLE FOR ANY DIRECT, INDIRECT, INCIDENTAL, SPECIAL, EXEMPLARY, OR CONSEQUENTIAL DAMAGES (INCLUDING, BUT NOT LIMITED TO, PROCUREMENT OF SUBSTITUTE GOODS OR SERVICES; LOSS OF USE, DATA, OR PROFITS; OR BUSINESS INTERRUPTION) HOWEVER CAUSED AND ON ANY THEORY OF LIABILITY, WHETHER IN CONTRACT, STRICT LIABILITY, OR TORT (INCLUDING NEGLIGENCE OR OTHERWISE) ARISING IN ANY WAY OUT OF THE USE OF THIS SOFTWARE, EVEN IF ADVISED OF THE POSSIBILITY OF SUCH DAMAGE.

However, parts of the NetBSD Kernel are provided with the following copyright notices.

Copyright (c) 1980, 1983, 1988, 1993 The Regents of the University of California. All rights reserved.

Copyright (c) 1980, 1986, 1989, 1993 The Regents of the University of California. All rights reserved.



Copyright (c) 1987, 1993 The Regents of the University of California. All rights reserved.  
Copyright (c) 1988 Regents of the University of California. All rights reserved  
Copyright (c) 1988 Stephen Deering.  
Copyright (c) 1988 University of Utah.  
Copyright (c) 1988, 1989, 1993 The Regents of the University of California. All rights reserved.  
Copyright (c) 1988, 1991, 1993 The Regents of the University of California. All rights reserved.  
Copyright (c) 1988, 1992, 1993 The Regents of the University of California. All rights reserved.  
Copyright (c) 1988, 1993 The Regents of the University of California. All rights reserved.  
Copyright (c) 1989 The Regents of the University of California. All rights reserved.  
Copyright (c) 1989, 1991, 1993 The Regents of the University of California. All rights reserved.  
Copyright (c) 1989, 1993 The Regents of the University of California. All rights reserved.  
Copyright (c) 1989, 1993, 1994 The Regents of the University of California. All rights reserved.  
Copyright (c) 1990, 1991, 1993 The Regents of the University of California. All rights reserved.  
Copyright (c) 1990, 1993 The Regents of the University of California. All rights reserved.  
Copyright (c) 1991, 1993 The Regents of the University of California. All rights reserved.  
Copyright (c) 1991, 1993, 1994 The Regents of the University of California. All rights reserved.  
Copyright (c) 1992 Regents of the University of California. All rights reserved.  
Copyright (c) 1992, 1993 The Regents of the University of California. All rights reserved.  
Copyright (c) 1993 The Regents of the University of California. All rights reserved.  
Copyright (c) 1993 Adam Glass  
Copyright (C) 1993 by Sun Microsystems, Inc. All rights reserved.  
Copyright (c) 1994 Gordon W. Ross  
Copyright (c) 1994 Winning Strategies, Inc. All rights reserved.  
Copyright (c) 1995 The Regents of the University of California. All rights reserved.  
Copyright (C) 1995, 1996, 1997, and 1998 WIDE Project. All rights reserved.  
Copyright (c) 1996 The Regents of the University of California. All rights reserved.  
Copyright (c) 1996 John S. Dyson All rights reserved.  
Copyright (c) 1996 Matt Thomas. All rights reserved.  
Copyright (c) 1996 Matthew R. Green. All rights reserved.  
Copyright (c) 1996 Paul Kranenburg  
Copyright (c) 1996, 1997, 1999, 2001 The NetBSD Foundation, Inc. All rights reserved.  
Copyright (c) 1996, 2000 Christopher G. Demetriou. All rights reserved.  
Copyright (c) 1996, 1999 by Internet Software Consortium.  
Copyright (c) 1996-1999 by Internet Software Consortium.  
Copyright (c) 1997 Jonathan Stone and Jason R. Thorpe. All rights reserved.  
Copyright (c) 1997 Christos Zoulas. All rights reserved.  
Copyright (c) 1997 Manuel Bouyer. All rights reserved.  
Copyright (c) 1997, 1998 The NetBSD Foundation, Inc. All rights reserved.  
Copyright (c) 1997, 1998, 1999, 2000 The NetBSD Foundation, Inc. All rights reserved.  
Copyright (c) 1997, 1998, 1999, 2001 The NetBSD Foundation, Inc. All rights reserved.  
Copyright (c) 1997, 1998, 1999, 2002 The NetBSD Foundation, Inc. All rights reserved.  
Copyright (c) 1997, 1998, 2000, 2001 The NetBSD Foundation, Inc. All rights reserved.  
Copyright (c) 1997, 1998, 2001 The NetBSD Foundation, Inc. All rights reserved.  
Copyright (c) 1997, 98 The NetBSD Foundation, Inc. All rights reserved.  
Copyright (C) 1997-2000 Sony Computer Science Laboratories Inc. All rights reserved.  
Copyright (c) 1997-2002 The NetBSD Foundation, Inc. All rights reserved.  
Copyright (c) 1998 The NetBSD Foundation, Inc. All rights reserved.  
Copyright (c) 1998 Todd C. Miller <Todd.Miller@courtesan.com> All rights reserved.  
Copyright (c) 1998, 1999 The NetBSD Foundation, Inc. All rights reserved.  
Copyright (c) 1998, 1999, 2000 The NetBSD Foundation, Inc. All rights reserved.

Copyright (c) 1998, 1999, 2000, 2001 The NetBSD Foundation, Inc. All rights reserved.  
Copyright (c) 1998, 2000 The NetBSD Foundation, Inc. All rights reserved.  
Copyright (c) 1998, 2000, 2001 The NetBSD Foundation, Inc. All rights reserved.  
Copyright (c) 1999 The NetBSD Foundation, Inc. All rights reserved.  
Copyright (C) 1999 WIDE Project. All rights reserved.  
Copyright (c) 1999, 2000 Jason L. Wright (jason@thought.net) All rights reserved.  
Copyright (c) 1999, 2000 The NetBSD Foundation, Inc. All rights reserved.  
Copyright (c) 1999, 2000, 2001 The NetBSD Foundation, Inc. All rights reserved.  
Copyright (c) 1999, 2001 The NetBSD Foundation, Inc. All rights reserved.  
Copyright (c) 2000 The NetBSD Foundation, Inc. All rights reserved.  
Copyright (c) 2000, 2001 The NetBSD Foundation, Inc. All rights reserved.  
Copyright (c) 2000, 2001, 2002 The NetBSD Foundation, Inc. All rights reserved.  
Copyright (c) 2001 The NetBSD Foundation, Inc. All rights reserved.  
Copyright (c) 2002 The NetBSD Foundation, Inc. All rights reserved.  
Copyright 1998 Massachusetts Institute of Technology. All rights reserved.  
Copyright 2001 Wasabi Systems, Inc. All rights reserved.  
Portions Copyright (c) 1993 by Digital Equipment Corporation.  
Portions Copyright (c) 1995 by International Business Machines, Inc.  
Copyright (c) 1983, 1989 The Regents of the University of California. All rights reserved.  
Copyright (c) 1996 by Internet Software Consortium. All rights reserved.  
Copyright (c) 1980, 1986, 1989 Regents of the University of California. All rights reserved.  
Copyright (c) 1988 The Regents of the University of California. All rights reserved.  
Copyright (c) 1992, 1993 The Regents of the University of California. All rights reserved.  
Copyright (c) 1994 Christopher G. Demetriou. All rights reserved.  
Copyright (c) 1997 The NetBSD Foundation, Inc. All rights reserved.  
Copyright (c) 1999 The NetBSD Foundation, Inc. All rights reserved.  
Copyright (c) 2001 The NetBSD Foundation, Inc. All rights reserved.  
Copyright (c) 1996 Gardner Buchanan <gbuchanan@shl.com> All rights reserved.

Parts of the NetBSD Kernel are provided with the licenses that are slightly different from the above Berkeley-formed license. Please refer the source code of the NetBSD Kernel about the details.

The source code of the NetBSD Kernel is provided by the NetBSD CVS Repositories (<http://cvsweb.netbsd.org/bsdweb.cgi/>), and this product includes parts of the source code in the

following directories.

<http://cvsweb.netbsd.org/bsdweb.cgi/src/sys/kern/>  
<http://cvsweb.netbsd.org/bsdweb.cgi/src/sys/net/>  
<http://cvsweb.netbsd.org/bsdweb.cgi/src/sys/netinet/>

<<OpenSSL>>

The product includes software developed by the OpenSSL Project and it is used under the following license.

LICENSE ISSUES

=====

The OpenSSL toolkit stays under a dual license, i.e. both the conditions of the OpenSSL License and the original SSLeay license apply to the toolkit. See below for the actual license texts. Actually both licenses are BSD-style Open Source licenses. In case of any license issues related to OpenSSL please contact [openssl-core@openssl.org](mailto:openssl-core@openssl.org).

OpenSSL License

-----

/\* =====

## Open Source Software

---

\* Copyright (c) 1998-2004 The OpenSSL Project. All rights reserved.

\*

\* Redistribution and use in source and binary forms, with or without  
\* modification, are permitted provided that the following conditions  
\* are met:

\*

\* 1. Redistributions of source code must retain the above copyright  
\* notice, this list of conditions and the following disclaimer.

\*

\* 2. Redistributions in binary form must reproduce the above copyright  
\* notice, this list of conditions and the following disclaimer in  
\* the documentation and/or other materials provided with the  
\* distribution.

\*

\* 3. All advertising materials mentioning features or use of this  
\* software must display the following acknowledgment:  
\* "This product includes software developed by the OpenSSL Project  
\* for use in the OpenSSL Toolkit. (<http://www.openssl.org/>)"

\*

\* 4. The names "OpenSSL Toolkit" and "OpenSSL Project" must not be used to  
\* endorse or promote products derived from this software without  
\* prior written permission. For written permission, please contact  
\* [openssl-core@openssl.org](mailto:openssl-core@openssl.org).

\*

\* 5. Products derived from this software may not be called "OpenSSL"  
\* nor may "OpenSSL" appear in their names without prior written  
\* permission of the OpenSSL Project.

\*

\* 6. Redistributions of any form whatsoever must retain the following  
\* acknowledgment:

\* "This product includes software developed by the OpenSSL Project  
\* for use in the OpenSSL Toolkit (<http://www.openssl.org/>)"

\*

\* THIS SOFTWARE IS PROVIDED BY THE OpenSSL PROJECT ``AS IS'' AND ANY  
\* EXPRESSED OR IMPLIED WARRANTIES, INCLUDING, BUT NOT LIMITED TO, THE  
\* IMPLIED WARRANTIES OF MERCHANTABILITY AND FITNESS FOR A PARTICULAR  
\* PURPOSE ARE DISCLAIMED. IN NO EVENT SHALL THE OpenSSL PROJECT OR  
\* ITS CONTRIBUTORS BE LIABLE FOR ANY DIRECT, INDIRECT, INCIDENTAL,  
\* SPECIAL, EXEMPLARY, OR CONSEQUENTIAL DAMAGES (INCLUDING, BUT  
\* NOT LIMITED TO, PROCUREMENT OF SUBSTITUTE GOODS OR SERVICES;  
\* LOSS OF USE, DATA, OR PROFITS; OR BUSINESS INTERRUPTION)  
\* HOWEVER CAUSED AND ON ANY THEORY OF LIABILITY, WHETHER IN CONTRACT,  
\* STRICT LIABILITY, OR TORT (INCLUDING NEGLIGENCE OR OTHERWISE)  
\* ARISING IN ANY WAY OUT OF THE USE OF THIS SOFTWARE, EVEN IF ADVISED  
\* OF THE POSSIBILITY OF SUCH DAMAGE.

=====

\*

\* This product includes cryptographic software written by Eric Young  
\* ([eyay@cryptsoft.com](mailto:eyay@cryptsoft.com)). This product includes software written by Tim  
\* Hudson ([tjh@cryptsoft.com](mailto:tjh@cryptsoft.com)).

\*

\*/

Original SSLeay License

-----

/\* Copyright (C) 1995-1998 Eric Young ([eyay@cryptsoft.com](mailto:eyay@cryptsoft.com))

\* All rights reserved.

- \*
  - \* This package is an SSL implementation written
  - \* by Eric Young (eay@cryptsoft.com).
  - \* The implementation was written so as to conform with Netscapes SSL.
  - \*
    - \* This library is free for commercial and non-commercial use as long as
    - \* the following conditions are aheared to. The following conditions
    - \* apply to all code found in this distribution, be it the RC4, RSA,
    - \* lhash, DES, etc., code; not just the SSL code. The SSL documentation
    - \* included with this distribution is covered by the same copyright terms
    - \* except that the holder is Tim Hudson (tjh@cryptsoft.com).
    - \*
      - \* Copyright remains Eric Young's, and as such any Copyright notices in
      - \* the code are not to be removed.
      - \* If this package is used in a product, Eric Young should be given attribution
      - \* as the author of the parts of the library used.
      - \* This can be in the form of a textual message at program startup or
      - \* in documentation (online or textual) provided with the package.
      - \*
        - \* Redistribution and use in source and binary forms, with or without
        - \* modification, are permitted provided that the following conditions
        - \* are met:
          - \* 1. Redistributions of source code must retain the copyright
          - \* notice, this list of conditions and the following disclaimer.
          - \* 2. Redistributions in binary form must reproduce the above copyright
          - \* notice, this list of conditions and the following disclaimer in the
          - \* documentation and/or other materials provided with the distribution.
          - \* 3. All advertising materials mentioning features or use of this software
          - \* must display the following acknowledgement:
            - \* "This product includes cryptographic software written by
            - \* Eric Young (eay@cryptsoft.com)"
            - \* The word 'cryptographic' can be left out if the rouines from the library
            - \* being used are not cryptographic related :-).
          - \* 4. If you include any Windows specific code (or a derivative thereof) from
          - \* the apps directory (application code) you must include an acknowledgement:
            - \* "This product includes software written by Tim Hudson (tjh@cryptsoft.com)"
        - \* THIS SOFTWARE IS PROVIDED BY ERIC YOUNG ``AS IS" AND
        - \* ANY EXPRESS OR IMPLIED WARRANTIES, INCLUDING, BUT NOT LIMITED TO, THE
        - \* IMPLIED WARRANTIES OF MERCHANTABILITY AND FITNESS FOR A PARTICULAR
        - \* PURPOSE
        - \* ARE DISCLAIMED. IN NO EVENT SHALL THE AUTHOR OR CONTRIBUTORS BE
        - \* LIABLE
        - \* FOR ANY DIRECT, INDIRECT, INCIDENTAL, SPECIAL, EXEMPLARY, OR
        - \* CONSEQUENTIAL
        - \* DAMAGES (INCLUDING, BUT NOT LIMITED TO, PROCUREMENT OF SUBSTITUTE
        - \* GOODS
        - \* OR SERVICES; LOSS OF USE, DATA, OR PROFITS; OR BUSINESS INTERRUPTION)
        - \* HOWEVER CAUSED AND ON ANY THEORY OF LIABILITY, WHETHER IN CONTRACT,
        - \* STRICT
        - \* LIABILITY, OR TORT (INCLUDING NEGLIGENCE OR OTHERWISE) ARISING IN ANY
        - \* WAY
        - \* OUT OF THE USE OF THIS SOFTWARE, EVEN IF ADVISED OF THE POSSIBILITY OF
        - \* SUCH DAMAGE.
        - \*
          - \* The licence and distribution terms for any publically available version or

## Open Source Software

---

\* derivative of this code cannot be changed. i.e. this code cannot simply be  
\* copied and put under another distribution licence  
\* [including the GNU Public Licence.]  
\*/

<<MD5>>

This software uses the Source Code of RSA Data Security, Inc. described in the RFC1321 (MD5 Message-Digest Algorithm).

-----  
Copyright (C) 1991-2, RSA Data Security, Inc. Created 1991. All rights reserved.

License to copy and use this software is granted provided that it is identified as the "RSA Data Security, Inc. MD5 Message-Digest Algorithm" in all material mentioning or referencing this software or this function.

License is also granted to make and use derivative works provided that such works are identified as "derived from the RSA Data Security, Inc. MD5 Message-Digest Algorithm" in all material mentioning or referencing the derived work.

RSA Data Security, Inc. makes no representations concerning either the merchantability of this software or the suitability of this software for any particular purpose. It is provided "as is" without express or implied warranty of any kind.

These notices must be retained in any copies of any part of this documentation and/or software.

<<MT19937>>

The MT19937 software that Takuji Nishimura and Makoto Matsumoto developed is contained, and this product shall be used subject to the following license conditions.

Copyright (C) 1997 - 2002, Makoto Matsumoto and Takuji Nishimura, All rights reserved.

Redistribution and use in source and binary forms, with or without modification, are permitted provided that the following conditions are met:

1. Redistributions of source code must retain the above copyright notice, this list of conditions and the following disclaimer.
2. Redistributions in binary form must reproduce the above copyright notice, this list of conditions and the following disclaimer in the documentation and/or other materials provided with the distribution.
3. The names of its contributors may not be used to endorse or promote products derived from this software without specific prior written permission.

THIS SOFTWARE IS PROVIDED BY THE COPYRIGHT HOLDERS AND CONTRIBUTORS

"AS IS" AND ANY EXPRESS OR IMPLIED WARRANTIES, INCLUDING, BUT NOT

LIMITED TO, THE IMPLIED WARRANTIES OF MERCHANTABILITY AND FITNESS FOR A PARTICULAR PURPOSE ARE DISCLAIMED. IN NO EVENT SHALL THE COPYRIGHT OWNER OR CONTRIBUTORS BE LIABLE FOR ANY DIRECT, INDIRECT, INCIDENTAL, SPECIAL, EXEMPLARY, OR CONSEQUENTIAL DAMAGES (INCLUDING, BUT NOT LIMITED TO, PROCUREMENT OF SUBSTITUTE GOODS OR SERVICES; LOSS OF USE, DATA, OR PROFITS; OR BUSINESS INTERRUPTION) HOWEVER CAUSED AND ON ANY THEORY OF LIABILITY, WHETHER IN CONTRACT, STRICT LIABILITY, OR TORT (INCLUDING NEGLIGENCE OR OTHERWISE) ARISING IN ANY WAY OUT OF THE USE OF THIS SOFTWARE, EVEN IF ADVISED OF THE POSSIBILITY OF SUCH DAMAGE.

<<thttpd>>

The thttpd software that ACME Labs developed is contained, and this product shall be used subject to the following license conditions.

Copyright 1995,1998,1999,2000 by Jef Poskanzer <jef@acme.com>.  
All rights reserved.

Redistribution and use in source and binary forms, with or without modification, are permitted provided that the following conditions are met:

1. Redistributions of source code must retain the above copyright notice, this list of conditions and the following disclaimer.
2. Redistributions in binary form must reproduce the above copyright notice, this list of conditions and the following disclaimer in the documentation and/or other materials provided with the distribution.

THIS SOFTWARE IS PROVIDED BY THE AUTHOR AND CONTRIBUTORS ``AS IS" AND ANY EXPRESS OR IMPLIED WARRANTIES, INCLUDING, BUT NOT LIMITED TO, THE IMPLIED WARRANTIES OF MERCHANTABILITY AND FITNESS FOR A PARTICULAR PURPOSE ARE DISCLAIMED. IN NO EVENT SHALL THE AUTHOR OR CONTRIBUTORS BE LIABLE FOR ANY DIRECT, INDIRECT, INCIDENTAL, SPECIAL, EXEMPLARY, OR CONSEQUENTIAL DAMAGES (INCLUDING, BUT NOT LIMITED TO, PROCUREMENT OF SUBSTITUTE GOODS OR SERVICES; LOSS OF USE, DATA, OR PROFITS; OR BUSINESS INTERRUPTION) HOWEVER CAUSED AND ON ANY THEORY OF LIABILITY, WHETHER IN CONTRACT, STRICT LIABILITY, OR TORT (INCLUDING NEGLIGENCE OR OTHERWISE) ARISING IN ANY WAY OUT OF THE USE OF THIS SOFTWARE, EVEN IF ADVISED OF THE POSSIBILITY OF SUCH DAMAGE.

## For your future reference

We recommend keeping a record of the following information to assist with any repair under warranty.

Serial No.

Date of purchase

---

(found on the back/bottom of the  
base unit)

Name and address of dealer

---

Attach your purchase receipt here.

# CE0682

Haagtechno bv  
Panasonic Infocenter  
Europalaan 30  
5232 BC 's-Hertogenbosch

Panasonic System Networks Co., Ltd.  
1-62, 4-chome, Minoshima, Hakata-ku, Fukuoka 812-8531, Japan

### Copyright:

This material is copyrighted by Panasonic System Networks Co., Ltd., and may be reproduced for internal use only. All other reproduction, in whole or in part, is prohibited without the written consent of Panasonic System Networks Co., Ltd.

© Panasonic System Networks Co., Ltd. 2010

**PNQX2864ZA** CM0310SY0